A decorative border made of watercolor-style illustrations of green leaves and colorful flowers (red, blue, purple, brown) is positioned around the edges of the page. The leaves are primarily on the left and right sides, while the flowers are clustered at the bottom right.

# Owner's Manual & Assembly Instructions

**TRASH BIN BOX - 2 DOORS**

# PREPARE

---

---

Please check all parts and components to ensure that there are no damages or missing items BEFORE starting the construction of the product.

**CAUTION: SOME PARTS HAVE SHARP EDGES. CARE MUST BE TAKEN WHEN HANDLING THE VARIOUS PIECES TO AVOID A MISHAP. FOR SAFETY SAKE, PLEASE READ SAFETY INFORMATION PROVIDED IN THIS MANUAL BEFORE BEGINNING.**

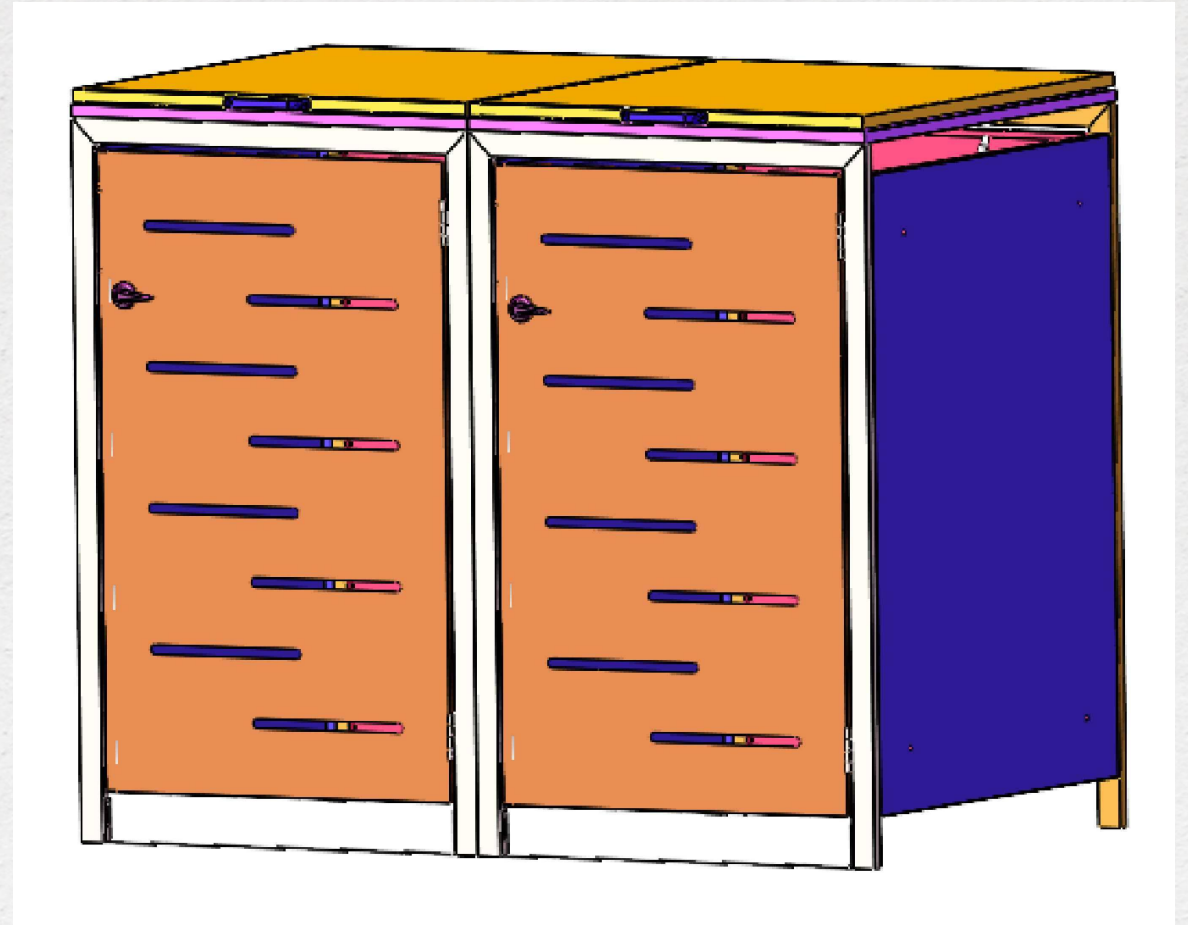

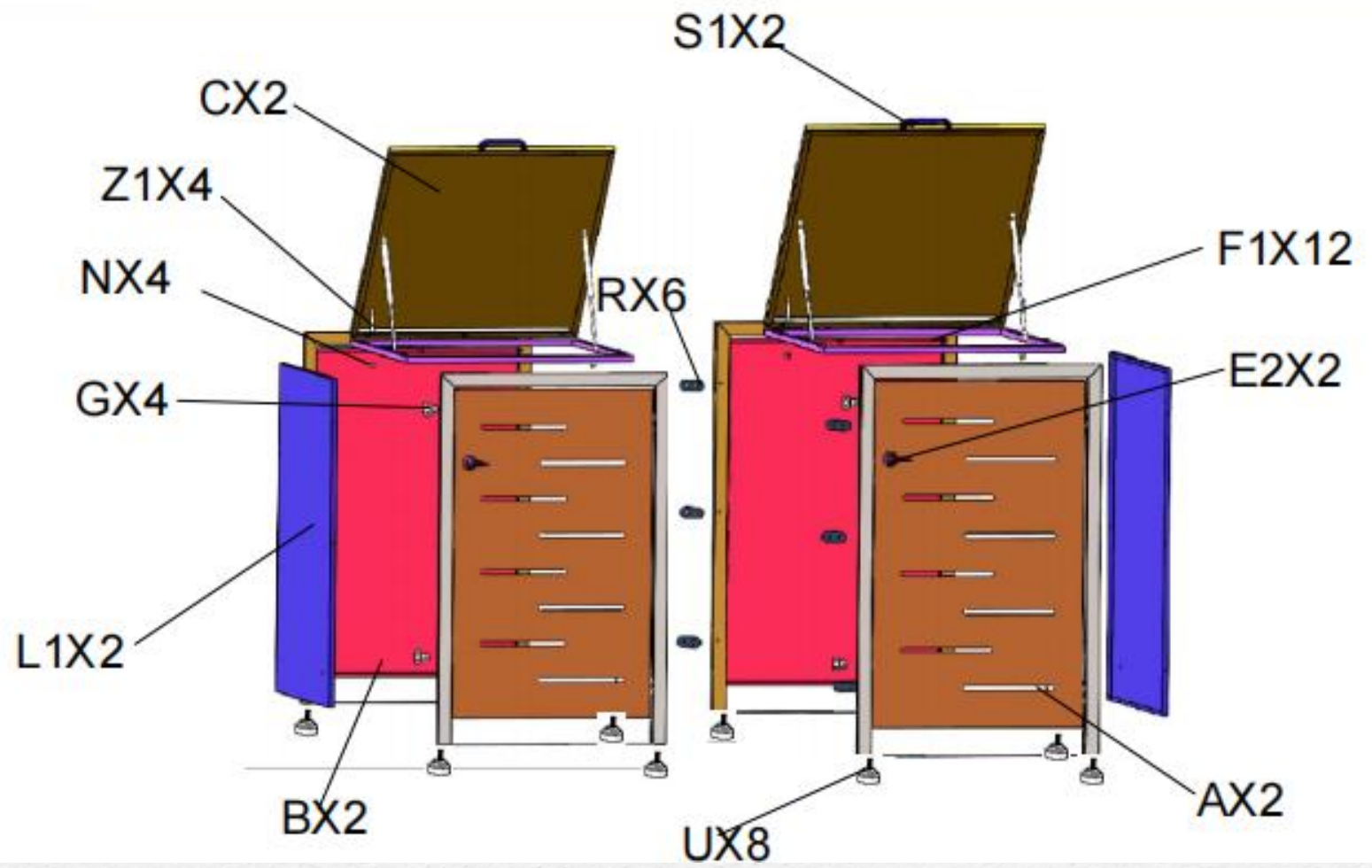

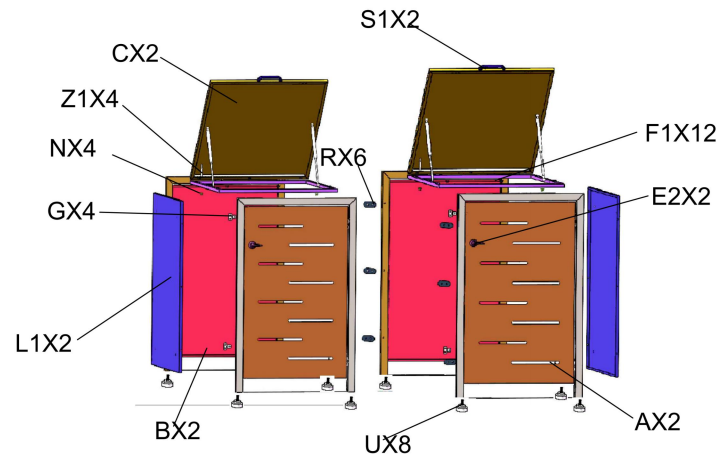

Front Door (AX2)	Rear Wall Panels (BX2)	Upper Cover (CX2)	Side Walls (L1X2)
Handle on the Door (E2X2)		Lock with magnet (E1X4)	Handle on Cover (S1X2)
Hook (T1X2)	Buckle (J1X6)	Rope (KX4)	Rubber Stopper (E1X12)
Damper (Z1X4)	Damper Plug (NX4)	Screws (E20X80)	
Expansion screws (E22X8)	Connector (RX6)	Foot Support (UX8)	Shim (E21X20)
	Nuts (M1X12)	1 set of wrench	

# STEP 1

A

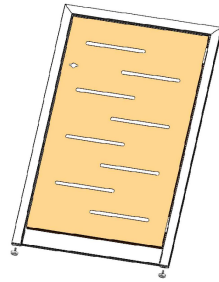

x2

U

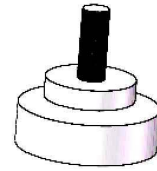

x2

E1

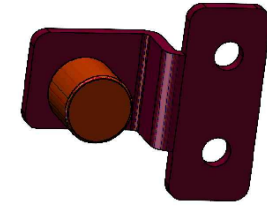

x2

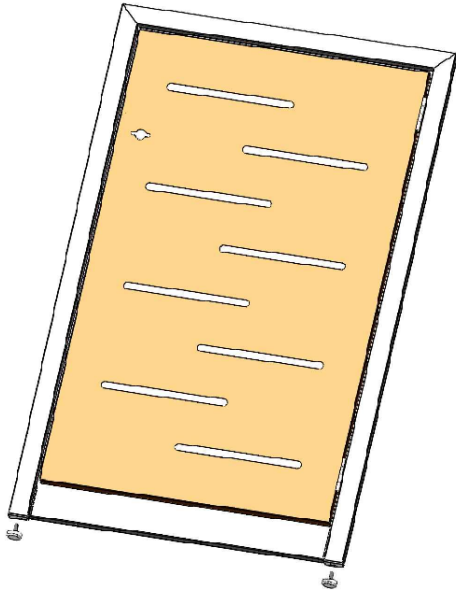

UX2

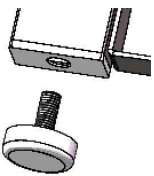

Install the U the support foot on the bottom of the door leaf as shown.

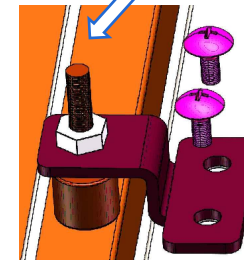
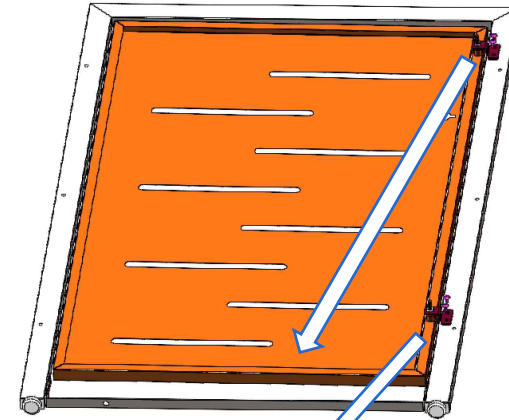

See the figure, install the E1 on the A, the door leaf as shown.

# STEP 2

B

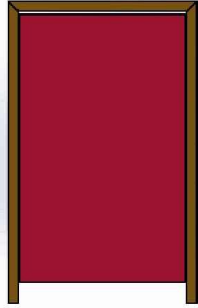

×1

L1

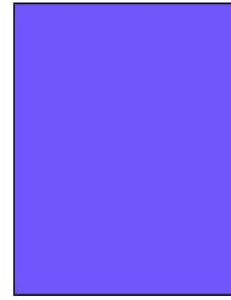

×2

U

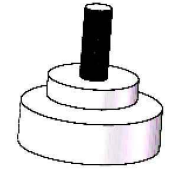

×2

As the figure shown,  
install the U (Foot Support)  
on the bottom of the rear  
wall panel

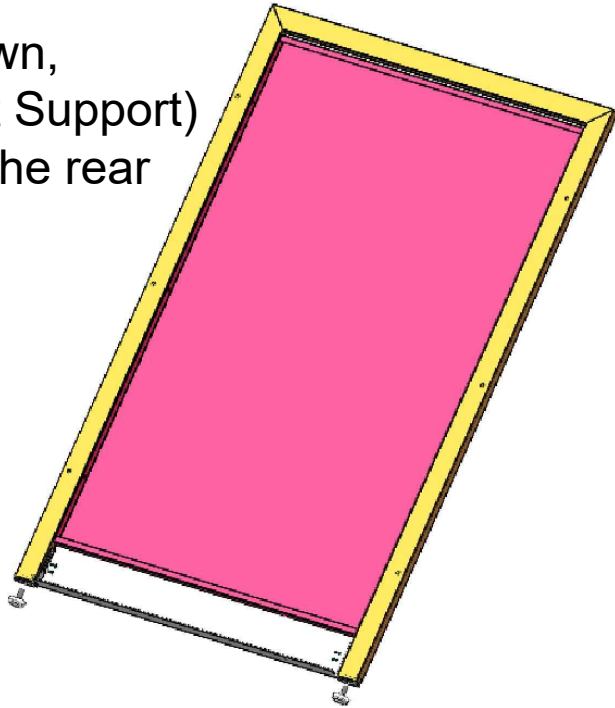
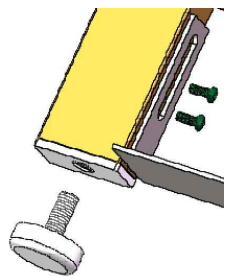

E20×6

Stand the L1×2 as shown ,use  
the screw to fix them with B(The  
rear Wall Panel tightly)

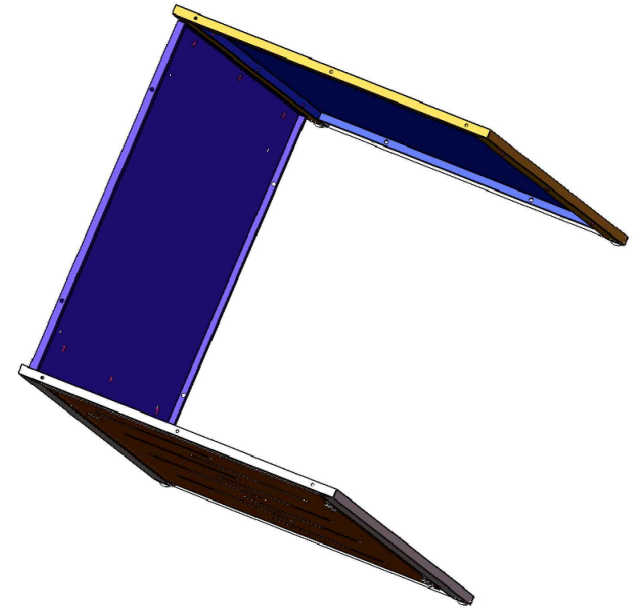

# STEP 3

C1

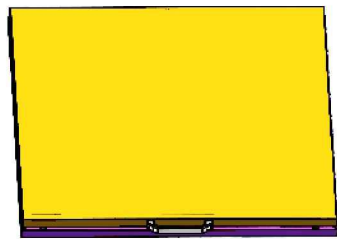

E20

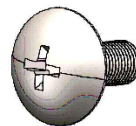

X6

E20X6

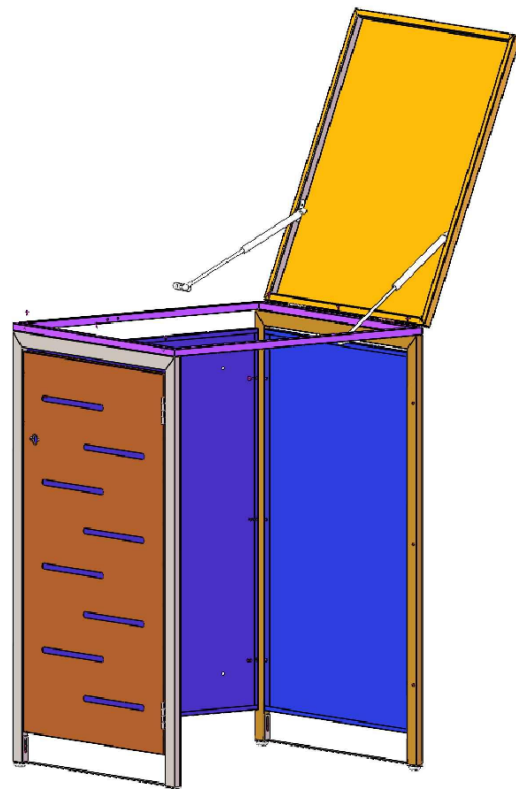
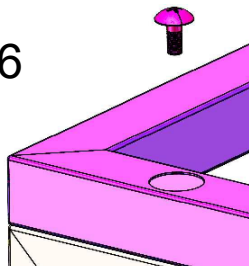

Install the C1 on the construction as shown, use the E20 the screws finish the fastening work.

# STEP 4

E20

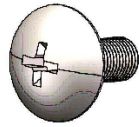

x4

Z1

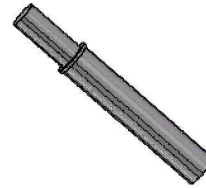

x2

N

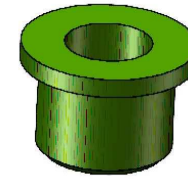

x2

E1



x6

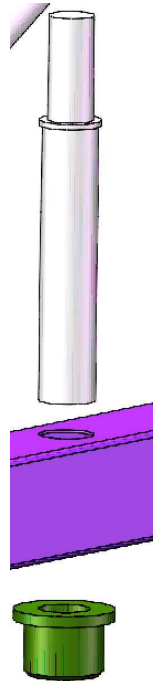

Z1X2

Put the Z1X2pcs to the Pre-setted holes as shown, then use the NX2pcs to cover it from the bottom.

NX2

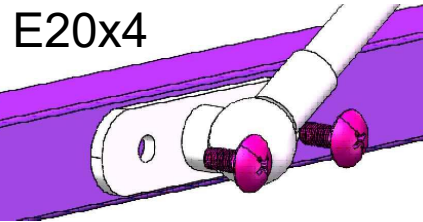

Install the C1 on the construction as shown

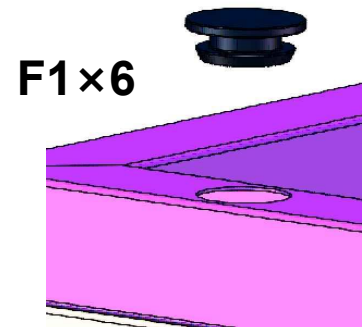

Put the rubber stop on the holes as shown.

Z1

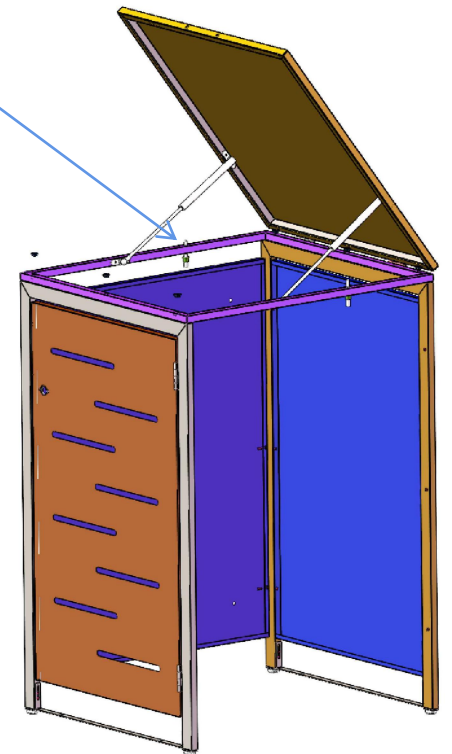

# STEP 5

S1



E2

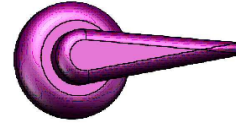

E20

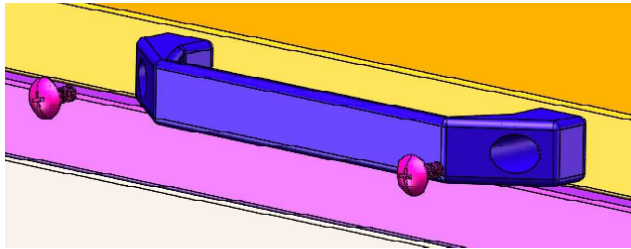
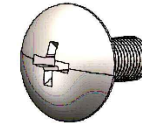

Install the S1  
(Handle) as shown

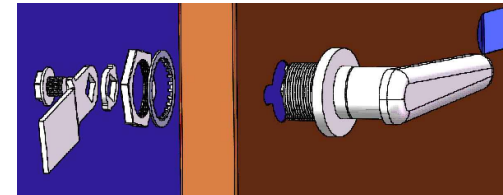
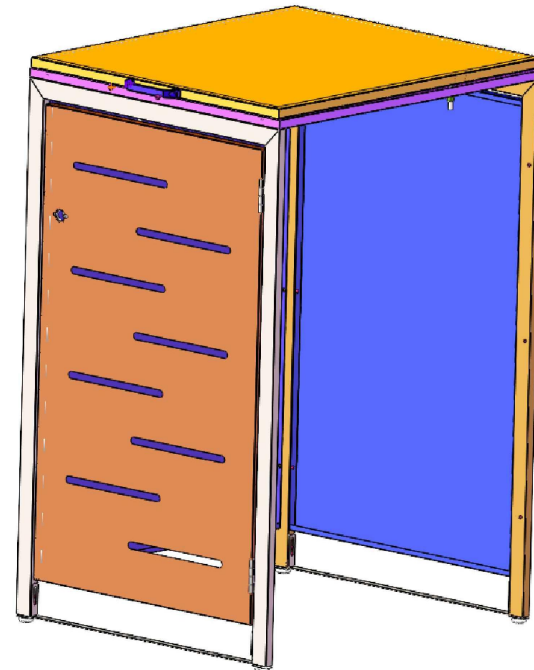

Install the handle  
E2 on the door  
leaf as shown

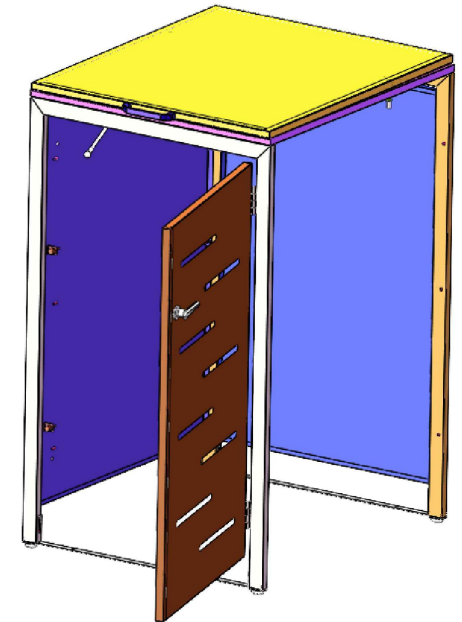

# STEP 6

T1



J1



E22

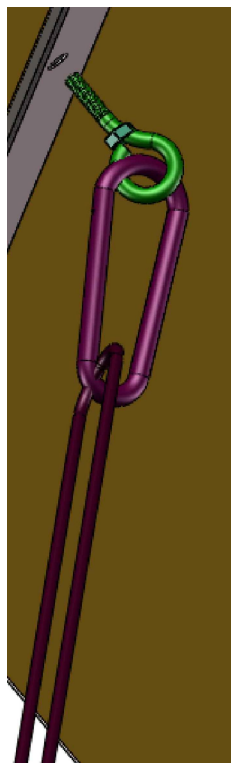

Set the T1 on the cover as shown

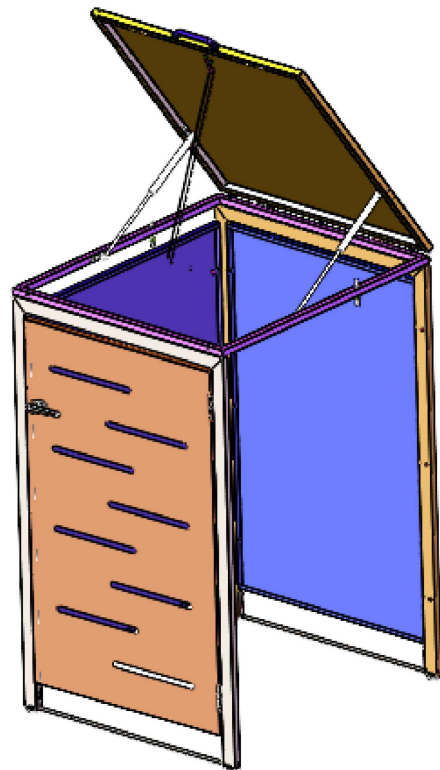

Repeat the previous steps to install another shed

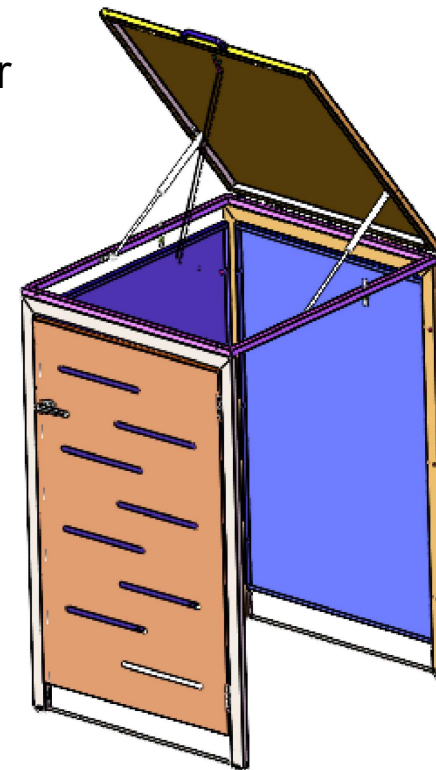

# STEP 7

R

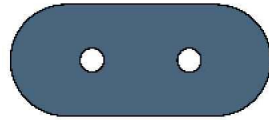

E20

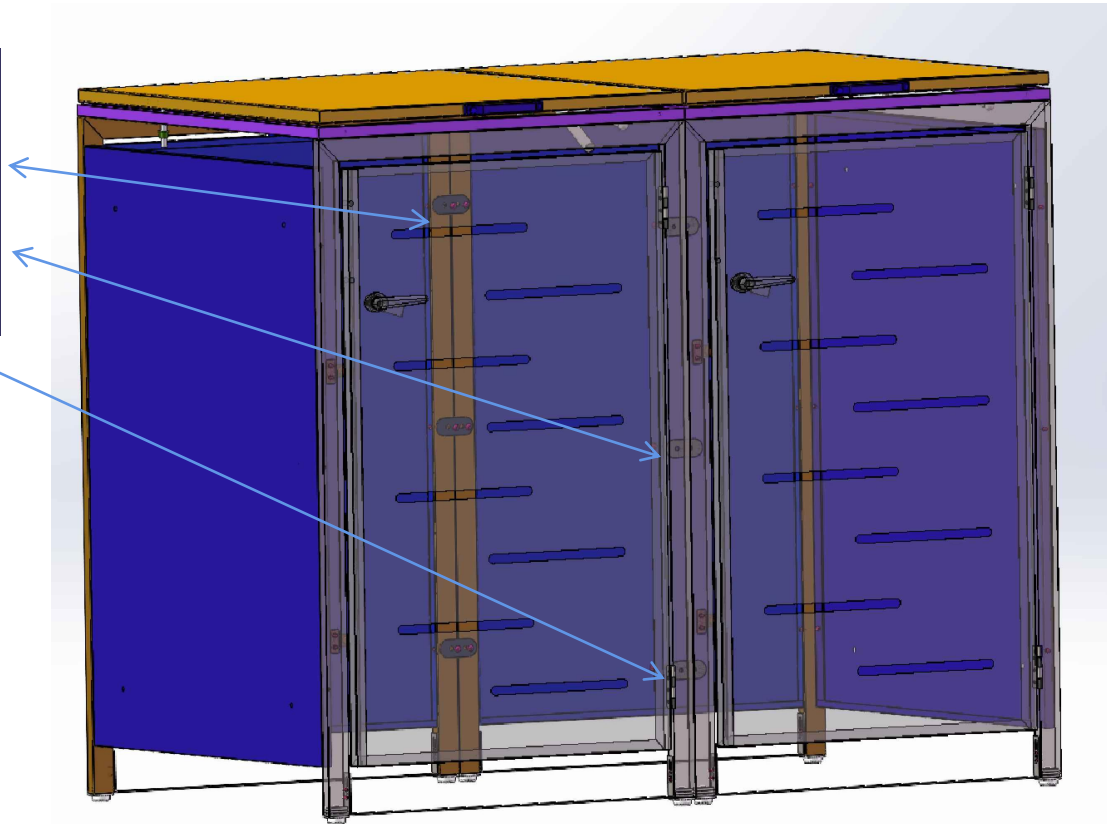
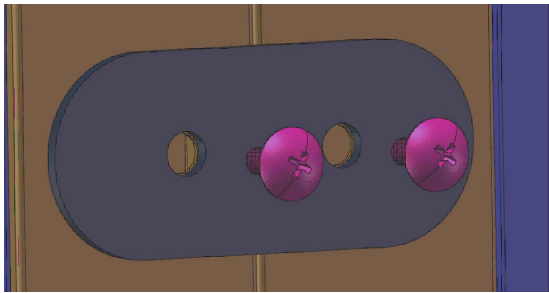
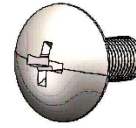

Connect these two sheds through using the RX6 pcs as shown.

# STEP 7

E22

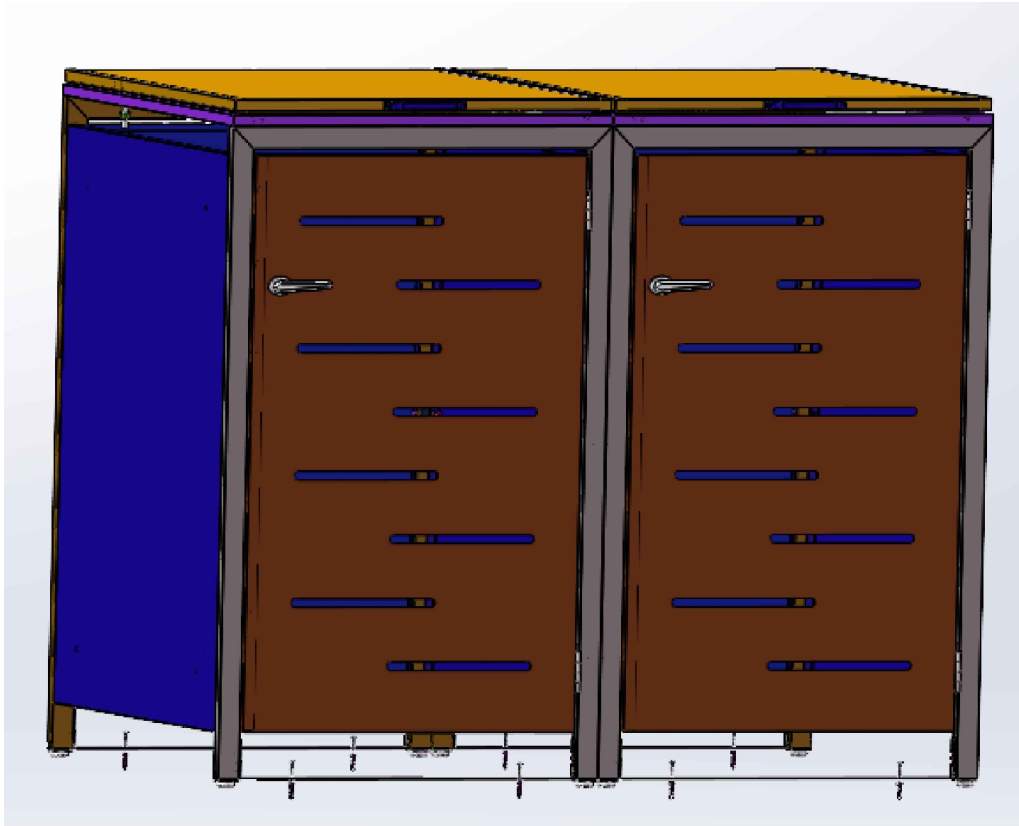

Drive the expansion screw into the ground through the hole as shown







Front set (AX3)



Rear wall set (BX3)



cover set (CX3)



Side panel (L1X4)



Lock and handle (E2X3)

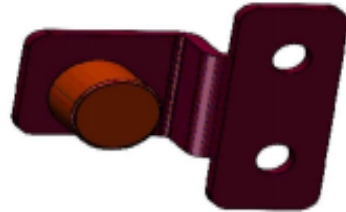

Magnetic lock (E1X6)



HANDLE ON COVER (S1X3)



Adjustable Support foot (UX12)



Hook on the cover (T1X3)



Buckle (J1X9)



Rope (KX6)



Rubber stopper (F1X18)



Damper (Z1X6)

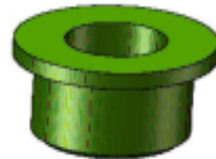

Damper plug (NX6)

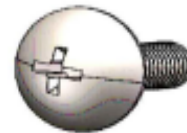

Screws (E20X120)

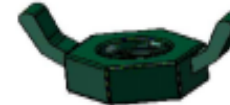

Thum screws (M1X6)



Expansion screws (E22X12)

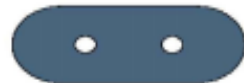

Connecting part (RX6)



Washer (E21X10)



Wrench 2 sets

Please read the manual of the installment of the trash bin -1 door and 2 door, then you connect them together, you will have this Trash bin box - 3 DOORS

Trash bin box-1 door

Trash bin box-2 doors

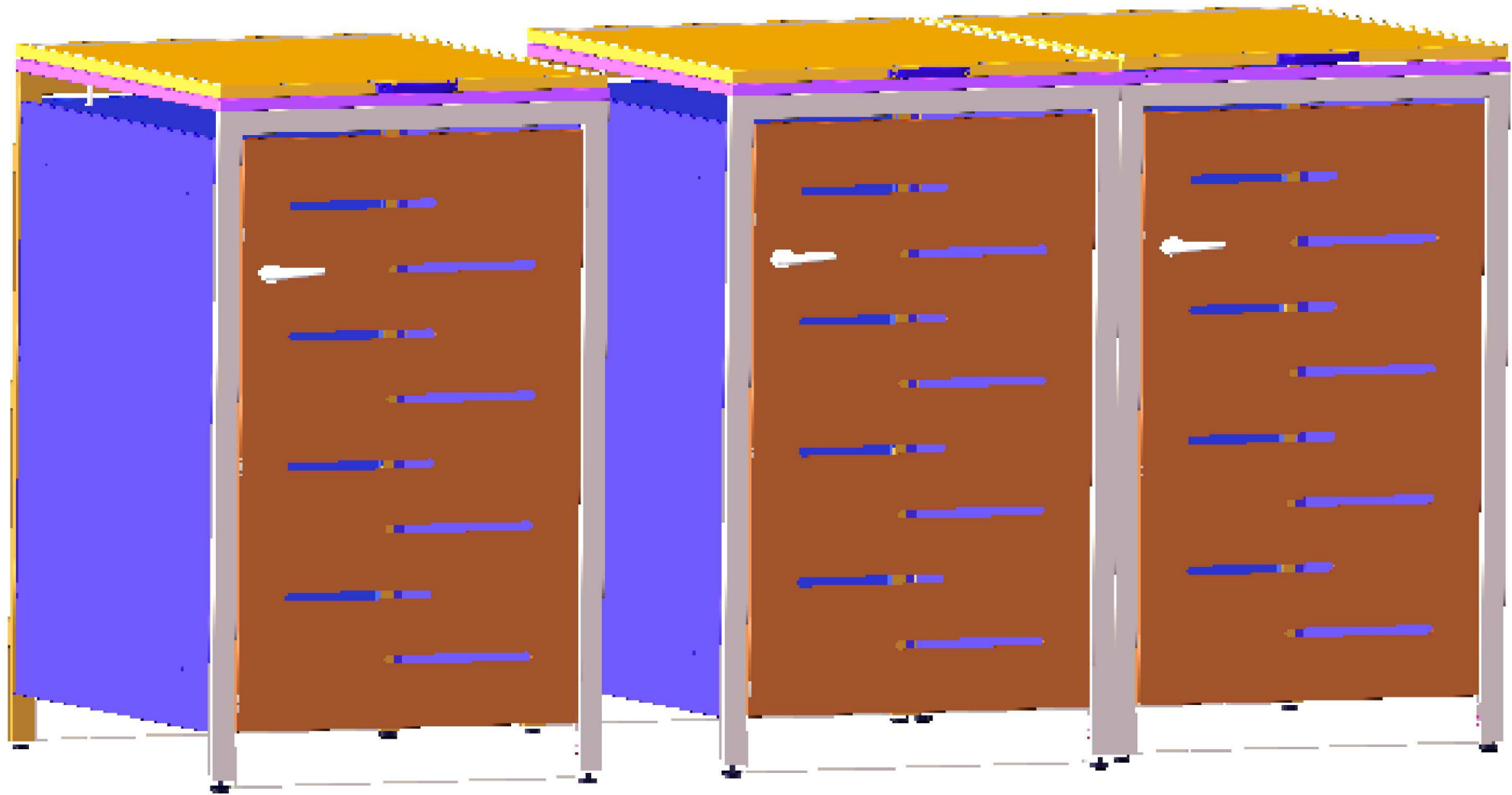

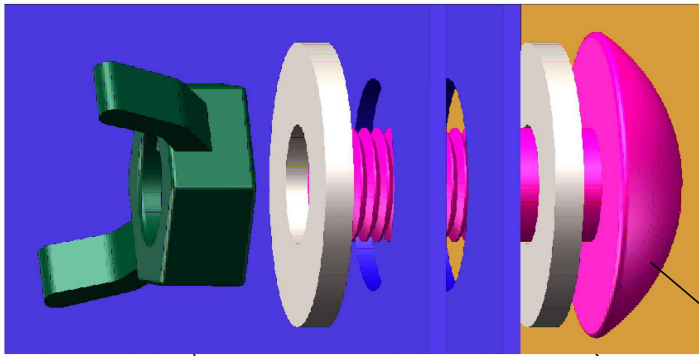

As the figure shown, use the M1 to connect this two rubbish bin box together through inside.

M1X4

E21X8

E20X4

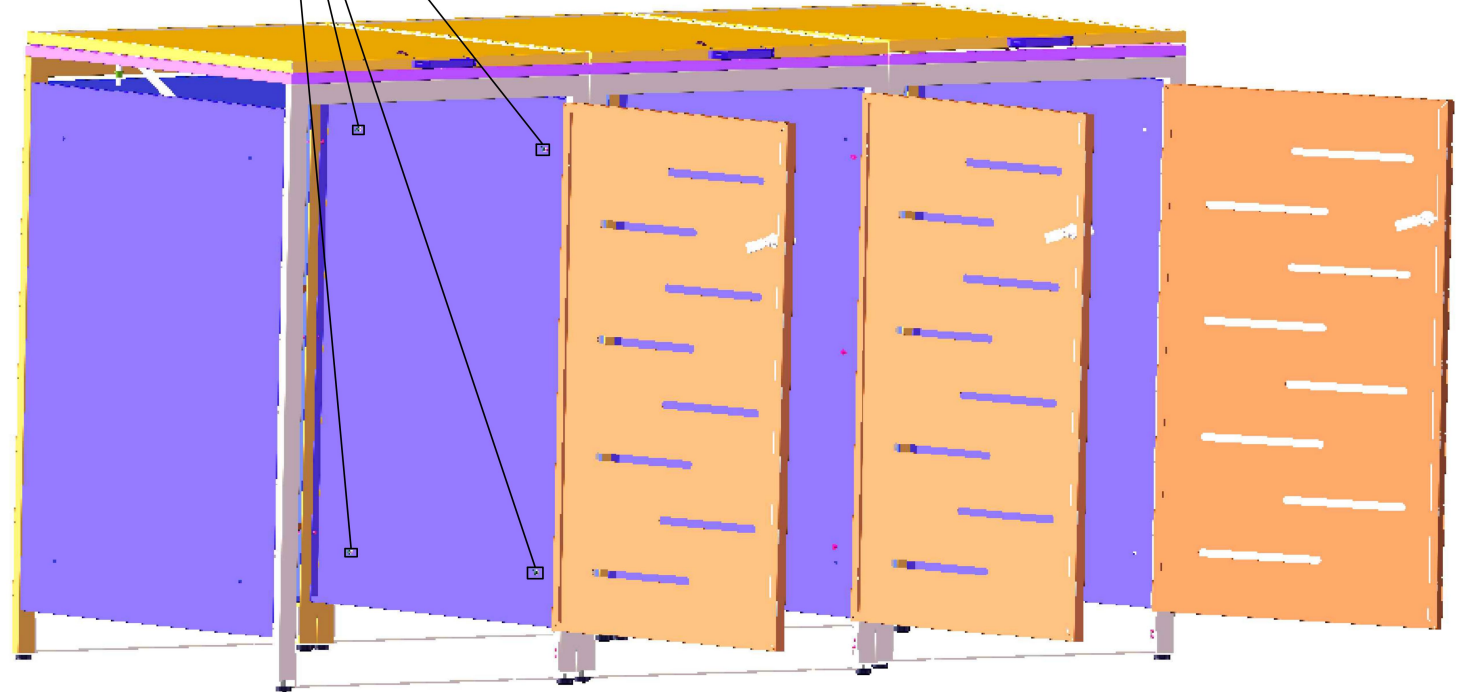



THANK YOU FOR WATCHING

